

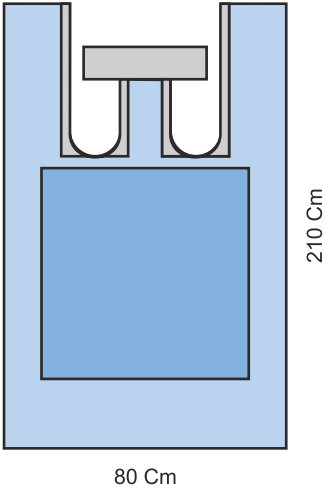

Cardiology Packs & Drapes

- **Single Drapes**
- **Cardiovascular Packs**
- **Pacemaker Packs**
- **Angiography Packs**
- **Perineal Packs**
- **Cathlab Packs**

PERINEAL DRAPE



Product Code #	Description	Size(cm)
42012-0000	Perineal Drape <ul style="list-style-type: none"> • Absorbent Laminated Reinforcement • Adhesive • 10x25 Cm Spit 	210x80

FENESTRATED DRAPE

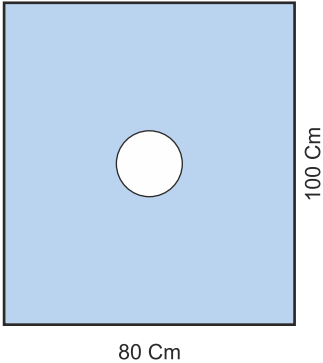

Product Code #	Description	Size(cm)
043-080-100S	Fenestrated Drape <ul style="list-style-type: none"> • 20 Cm Circular Fenestration 	100x80

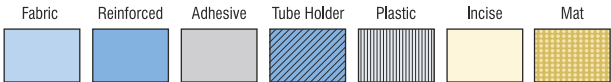

ANGIO DRAPE

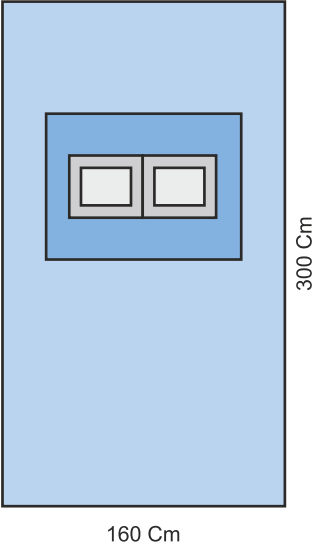

Product Code #	Description	Size(cm)
30011-0000	Angio Drape <ul style="list-style-type: none"> • 13x13 Cm Fenestration • Absorbent Laminated Reinforcement • Adhesive 	160x300

RADIAL DRAPE

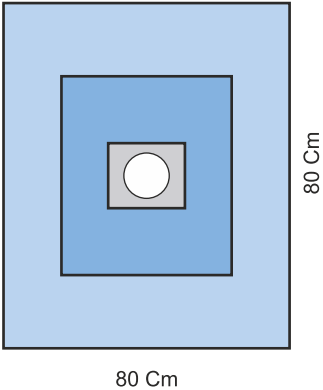

Product Code #	Description	Size(cm)
41103-0000	Radial Drape <ul style="list-style-type: none"> • 6 Cm Circular Fenestration • Absorbent Laminated Reinforcement • Adhesive 	80x80

SURGICAL SHEET WITH ABSORBENT REINFORCEMENT

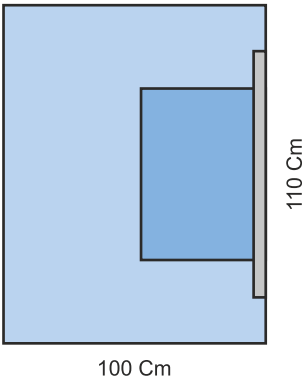

Product Code #	Description	Size(cm)
40014-0000	Surgical Sheet with Absorbent Reinforcement <ul style="list-style-type: none"> • Absorbent Laminated Reinforcement • Adhesive 	100x110

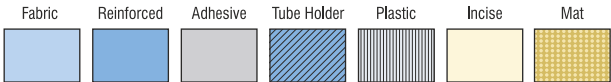

CABG DRAPE

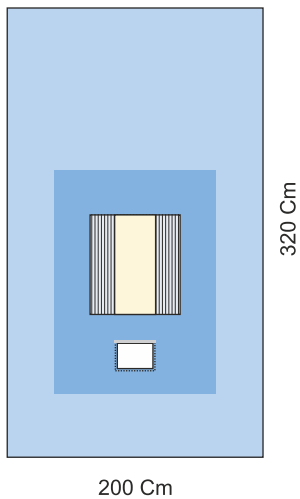

Product Code #	Description	Size(cm)
42001-0000	CABG Drape <ul style="list-style-type: none"> • Absorbent Laminated reinforcement • Adhesive • Fluid Collection Pouch • Incise • 45x20 fenestration 	320x200

BILATERAL UNDER LEG DRAPE

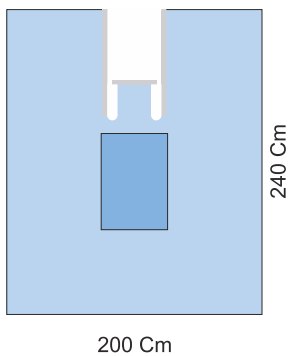

Product Code #	Description	Size(cm)
42011-0000	Bilateral Under Drape <ul style="list-style-type: none"> • Absorbent Laminated reinforcement • Adhesive 	240x200

SCREEN SHEET

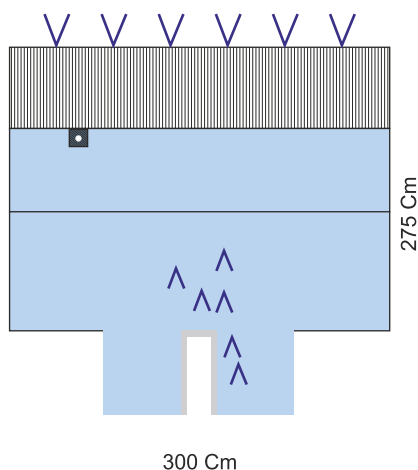

Product Code #	Description	Size(cm)
CR 143065-000	Screen Sheet <ul style="list-style-type: none"> • Transparent plastic • Adhesive 	300x275



FEMORAL DRAPE

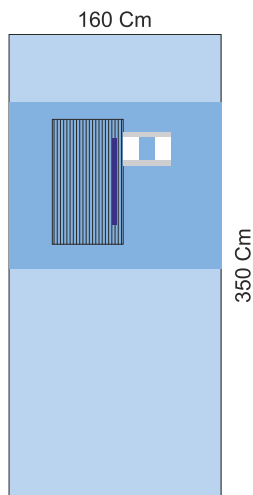

BACK VIEW

Product Code #	Description	Size(cm)
41104-0000	Femoral Drape <ul style="list-style-type: none"> • Absorbent Laminated reinforcement • Adhesive • Fluid Collection Pouch 	160x350

FEMORAL ANGIOGRAPHY DRAPE

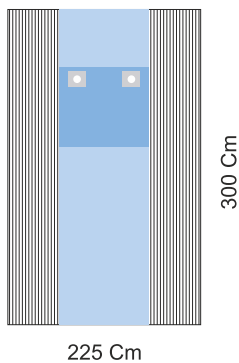

225 Cm

Product Code #	Description	Size(cm)
41105-0000	Femoral Angiography Drape <ul style="list-style-type: none"> • Absorbent Laminated reinforcement • Adhesive • Transparent Plastic Windows • 8 cm circular fenestration 	300x225

PACE MAKER DRAPE

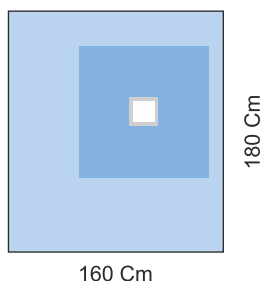

160 Cm

Product Code #	Description	Size(cm)
41110-0000	Pace Maker Drape <ul style="list-style-type: none"> • Absorbent Laminated reinforcement • Adhesive • 8 cm square fenestration 	160x180



RADIAL FEMORAL ANGIOGRAPHY DRAPE

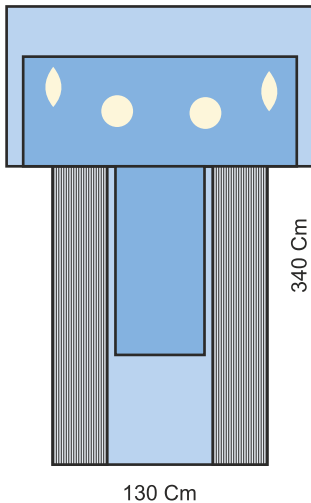

Product Code #	Description	Size(cm)
41103-0000	Radial Femoral Angiography Drape <ul style="list-style-type: none"> • 13 Cm Circular Fenestration • 9Cm Oval Fenestration • Absorbent Laminated Reinforcement • Incise • Milpoly Clear Plastic Windows 	130x340

RADIAL DRAPE

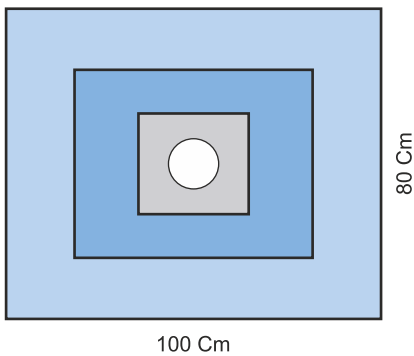

Product Code #	Description	Size(cm)
41102-0000	Radial Drape <ul style="list-style-type: none"> • 7Cm Circular Fenestration • Absorbent Laminated Reinforcement • Adhesive 	100x80

FEMORAL ANGIOGRAPHY DRAPE

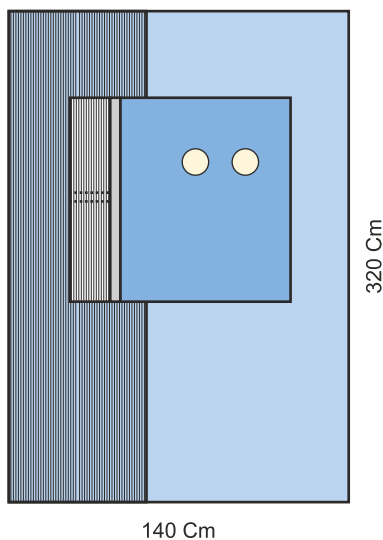

Product Code #	Description	Size(cm)
30011-0000	Femoral Angiography Drape <ul style="list-style-type: none"> • Absorbent Laminated Reinforcement • 13Cm Circular Fenestration • Incise • Clear Plastic Windows 	140x320



CABG Pack-I : Product Code - #66201-0001

CABG DRAPE

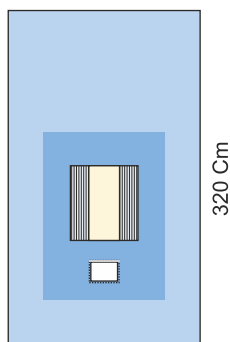

200 Cm

320 Cm

BILATERAL UNDER LEG DRAPE

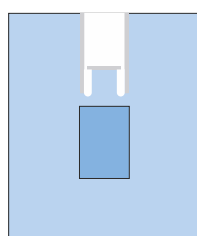

240 Cm

200 Cm

CONE SHAPE FOOT COVER

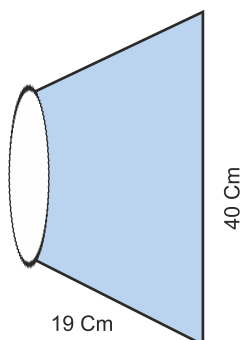

19 Cm

40 Cm

Item Code	Qty.	Contents	Size(cm)
085-160-225S	1 PC	Back Table Cover Reinforced	160x225
CR 143027-002	4 PCS	Surgical Gown GR 10	M
CR 143029-000	8 PCS	Hand Towels	
CR 143027-015	1 PC	Surgical Gown GR 10	L
CR 143029-000	2 PCS	Hand Towels	
42011-0000	1 PC	Bi-Lateral Underleg Drape	240x200
		<ul style="list-style-type: none"> • Adhesive • Absorbent Laminated Reinforcement • 10x25 Cm Split 	
043-160-160A	1 PC	Medium Drape with Adhesive	160x160
		<ul style="list-style-type: none"> • Adhesive 	
42001-0000	1 PC	Cardiovascular Drape	200x280
		<ul style="list-style-type: none"> • Adhesive • Incise • Absorbent Laminated Reinforcement • 45x20 Cm Fenestration 	
CC 142002-000	2 PCS	Cautery Bag	30x30
CC 142002-003	1 PC	Suture Bag	10x5
CC 142035-005	2 PC	Foot Cover Cone Shape	
CC 142043-001	2 PCS	ISO Seal Drape Tape Strips	45x5
065-050-050S	2 PCS	Absorbent Laminated Reinforcement	50x50
060-100-100S	1 PC	Absorbent Laminated Reinforcement	100x100
318-240-240S	1 PC	Trolley Sheet Large	240x240
085-160-125S	2 PCS	Trolley Sheet Medium	160x125
043-080-080A	1 PC	Surgical Sheet	80x80
		<ul style="list-style-type: none"> • Adhesive • Absorbent Laminated Reinforcement 	75x75
40015-0000	1 PC	Surgical Sheet Medium	
		<ul style="list-style-type: none"> • Adhesive • Absorbent Laminated Reinforcement 	160x120
40016-0000	1 PC	Surgical Sheet Small	150x100
		<ul style="list-style-type: none"> • Adhesive • Absorbent Laminated Reinforcement 	100x100
CR 142043-000	1 PC	ISO Seal Drape Tape Strips	75x75
CC 142035-005	1 PC	Hand Cover Cone Shape	10x45
40111-0000	2 PCS	Small Fenestrated Sheet	100x80
		<ul style="list-style-type: none"> • 8 Cm Circular Fenestration • Absorbent Laminated Reinforcement 	40x40
043-080-100A	3 PCS	Surgical Sheet Small	100x80
		<ul style="list-style-type: none"> • Adhesive 	
043-080-100S	1 PC	Surgical Sheet Small	100x80
CP 141066-000	1 PC	Carry Bag	

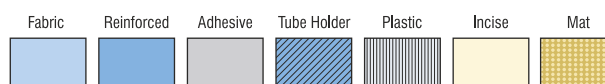

CABG Pack-II : Product Code - #66201-0002

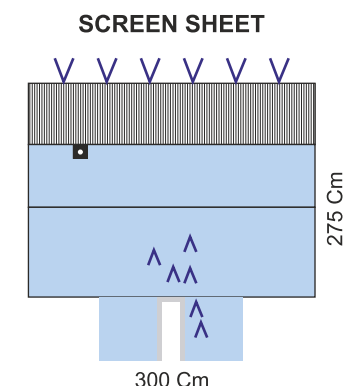

CONE SHAPE FOOT COVER

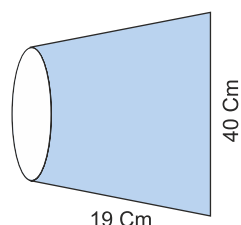

Item Code	Qty.	Contents	Size(cm)
085-160-225S	1 PC	Back Table Cover Reinforced	160x225
043-045-020A	1 PC	Perineal Sheet	45x20
043-1600-180S	1 PC	Bottom Drape	160x180
CC 142035-005	2 PCS	Foot Cover Cone Shape	80x80
CC 142043-001	5 PCS	ISO Seal Drape Tape Strips	5x45
043-045-500A	4 PCS	Chest Drape with Adhesive	45x50
043-080-100A	2 PCS	Side Drape with Adhesive	100x80
043-160-100S	1 PC	Abdominal Drape	160x100
043-160-100S	1 PC	Top Drape	160x100
CR 143065-000	1 PC	Screen Sheet	275x300
CR 142002-004	1 PC	Clear Plastic	
CR 142002-004	1 PC	Cautery Bag	35x25
CR 142002-003	1 PC	Cautery Bag	20x25
CC 142007-000	1 PC	Pump Sheet Carry Plastic 40 Micron	150x150
CP 141066-000	1 PC	Carry Bag	

Pace Maker Pack I : Product Code - #666731-0001

PACE MAKER DRAPE

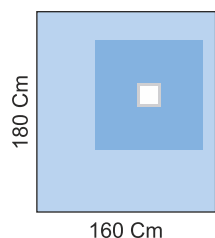

SURGICAL SHEET SMALL

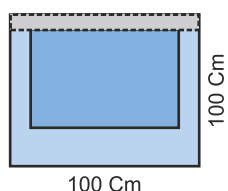

Item Code	Qty.	Contents	Size(cm)
085-160-100S	1 PC	Back Table Cover Reinforced	160x100
CR 143027-030	3 PCS	Surgical Gown Reinforced	L
CR 143029-000	3 PCS	Hand Towels	30x30
318-160-160S	1 PC	Trolley Sheet Laminated Reinforced	160x160
40018-0000	4 PCS	Surgical Sheet with Absorbent Reinforcement	100x110
043-160-200S	1 PC	Surgical Sheet	160x200
41110-000	1 PC	Pacemaker Drape	160x180
CP 141066-000	1 PC	Carry Bag	

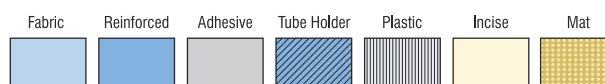

Pace Maker Pack II : Product Code - #66731-0002

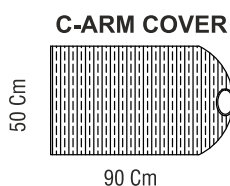
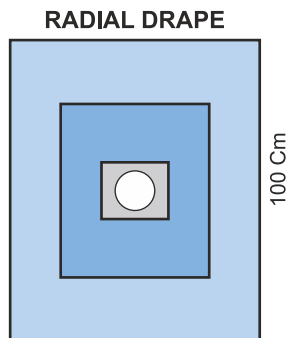

Item Code	Qty.	Contents	Size(cm)
318-160-080S	1 PC	Back Table Cover Reinforced	160x80
CR 143027-027	2 PCS	Over Lap Gown	L
CR 143029-000	2 PCS	Hand Towel	30x30
41102-0000	1 PC	Radial Drape	100x80
		<ul style="list-style-type: none"> • 7 Cm Circular Fenestration • Absorbent Laminated Reinforcement • Adhesive 	
085-160-125S	1 PC	Trolley Sheet	160x125
CR 143024-006	10 PCS	Gauze Swab X-Ray Detectable	7.5x7.5
CC 142001-000	1 PC	C-Arm Cover Transparent	50x90
CP 141066-000	1 PC	Carry Bag	

Pace Maker Pack III : Product Code - #66731-0003

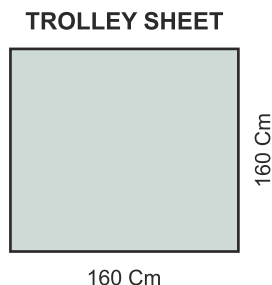
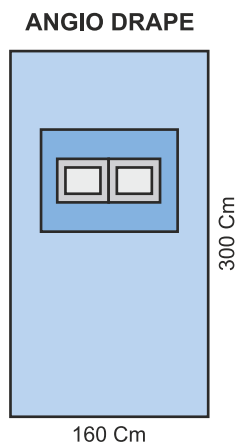

Item Code	Qty.	Contents	Size(cm)
085-160-100S	1 PC	Back Table Cover Reinforced	160x100
CR 143027-024	3 PCS	Surgical Gown	L
CR 143029-000	3 PCS	Hand Towel	30x30
318-160-160S	1 PC	Trolley Sheet Laminated Reinforcement	160x160
30011-0000	1 PC	Angio Drape	160x300
		<ul style="list-style-type: none"> • 13x13 Cm Square Fenestration • Absorbent Laminated Reinforcement • Adhesive 	
CP 141066-000	1 PC	Carry Bag	

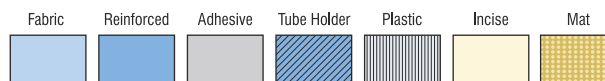

Radial Femoral Angiography Pack : Product Code - #66702-0000

RADIAL FEMORAL ANGIOGRAPHY DRAPE

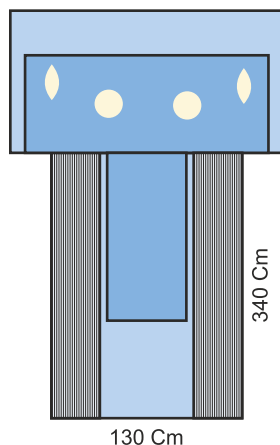

FLUROSCOPY COVER

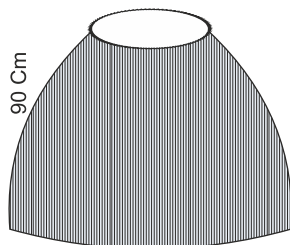

ANGIO PROTECTION COVER

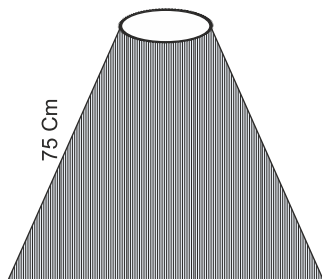

Item Code	Qty.	Contents	Size(cm)
085-160-100S	1 PC	Back Table Cover Reinforced	160x100
CR 143027-030	2 PCS	Surgical Gown Reinforced	L
CR 143029-000	2 PCS	Hand Towel	30x30
CC 142014-003	1 PC	Fluroscopy Cover	90x90
CC 142014-000	1 PC	Angio Protection Cover	85x75
CP 141081-002	1 PC	Bowl 500 CC	
CP 141081-003	1 PC	Bowl 1000 CC	
CR 143130-000	1 PC	Sponge Stick Blue 15 Cm	
CP 141081-006	1 PC	Half Deep Tray 10x25 Cm	
CR 143041-012	6 PCS	Mopping Pad	30x30
41103-0000	1 PC	Radial Femoral Angiography Drape	
		<ul style="list-style-type: none"> Absorbent Laminated Reinforcement Incise 13 Circular Fenestration 9 Cm Oval Fenestration Milpoly Clear Plastic Windows 	40 Microns
085-160-125S	1 PC	Trolley Sheet	160x125
CP 141066-000	1 PC	Carry Bag	

Femoral Angiogram Pack I : Product Code - #66011-0001

ANGIO DRAPE

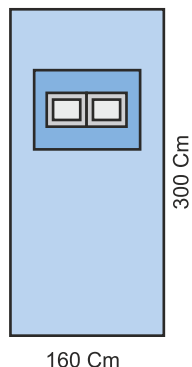

Item Code	Qty.	Contents	Size(cm)
318-080-100S	1 PC	Back Table Cover Reinforced	100x80
318-160-160S	1 PC	Trolley Sheet	160x160
30011-0000	1 PC	Angiogram Drape	160x300
		<ul style="list-style-type: none"> Absorbent Laminated Reinforcement 	160x300
CP 141066-000	1 PC	Carry Bag	

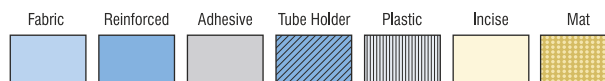

Femoral Angiography Pack II : Product Code - #66011-0002

FEMORAL ANGIOGRAPHY DRAPE

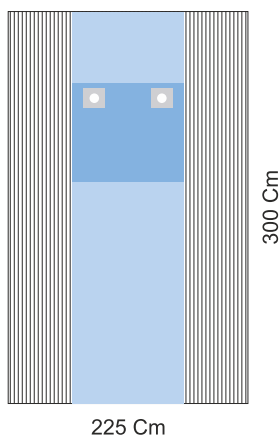

Item Code	Qty.	Contents	Size(cm)
085-160-125S	1 PC	Back Table Cover Reinforced	160x125
CR 143027-024	2 PCS	Surgical Gown	L
CR 143029-000	2 PCS	Hand Towel	30x30
CP 141081-005	2 PCS	Kidney Basin	
CR 143041-012	6 PCS	Mopping Pad	30x30
41105-0000	1 PC	Femoral Angiography Drape	225x300
		<ul style="list-style-type: none"> • 7 Cm Circular Fenestration • Absorbent Laminated Reinforcement • Incise • Clear Plastic Windows 40 Microns 	
085-160-125S	1 PC	Trolley Sheet	160x125
CP 141066-000	1 PC	Carry Bag	

TROLLEY SHEET

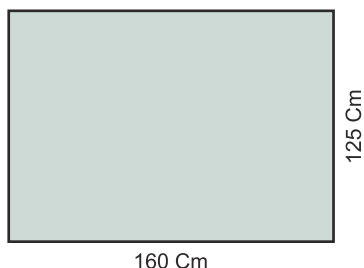

Femoral Angiography Pack III : Product Code - #66011-0003

FEMORAL ANGIOGRAPHY DRAPE

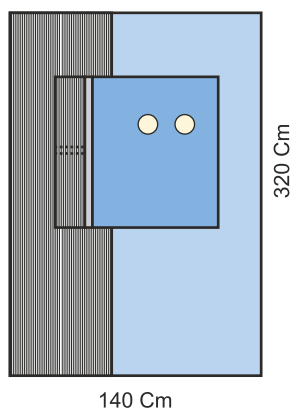

Item Code	Qty.	Contents	Size(cm)
085-160-100S	1 PC	Back Table Cover Reinforced	160x100
CR 143027-027	2 PCS	Surgical Gown Overlap	L
CR 143029-000	2 PCS	Hand Towel	30x30
30011-0000	1 PC	Angiography Drape	140x320
		<ul style="list-style-type: none"> • Absorbent Laminated Reinforcement • 13 Cm Circular Fenestration • Incise • Clear Plastic Window 	
318-160-160S	1 PC	Trolley Sheet Laminated Reinforced	160x160
CR 143041-012	6 PCS	Mopping Pad	30x30
CP 141066-000	1 PC	Carry Bag	

TROLLEY SHEET

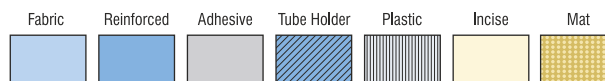
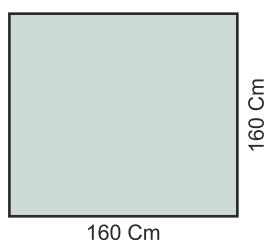

Perineal Pack I : Product Code - #66581-0001

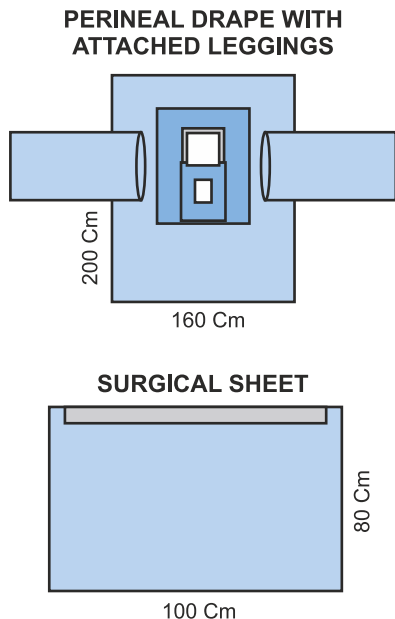

Item Code	Qty.	Contents	Size(cm)
085-160-100S	1 PC	Back Table Cover Reinforced	160x100
CR 143027-038	3 PCS	Surgical Gown Wrap Around	L
CR 143029-000	3 PCS	Hand Towels	30x30
318-160-160S	2 PCS	Trolley Sheet Laminated Reinforced	160x160
043-080-100A	2 PCS	Surgical Sheet	100x80
43101-0000	1 PC	Perineal Drape with Attached Leggings <ul style="list-style-type: none"> • 15 x20 Cm Perineal Fenestration • 30x30 Abdominal Fenestration • Absorbent Laminated Reinforcement • Adhesive • Leggings 	160x200
CP 141066-000	1 PC	Carry Bag	

Perineal Pack II : Product Code - #66581-0002

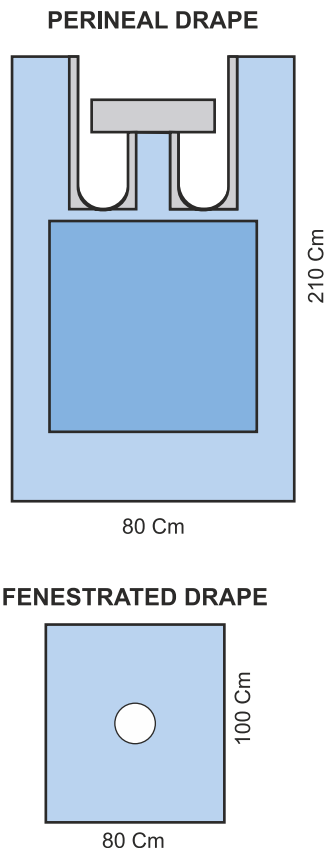

Item Code	Qty.	Contents	Size(cm)
085-160-125S	1 PC	Back Table Cover Reinforced	160x125
CR 143027-024	2 PCS	Surgical Gown	L
CR 143029-000	2 PCS	Hand Towels	30x30
043-080-100S	2 PCS	Surgical Sheet Medium	100x80
043-080-100S	1 PC	Fenestrated Sheet	100x80
CC 142005-000	2 PCS	Leggings	100x80
42012-0000	1 PC	Perineal Drape <ul style="list-style-type: none"> • Absorbent Laminated Reinforcement • Adhesive • 10x25 Cm Split 	210x200
318-160-200S	1 PC	Trolley Sheet Laminated Reinforcement	160x200
CR 143041-012	6 PCS	Mopping Pad	30x30
CP 141066-000	1 PC	Carry Bag	

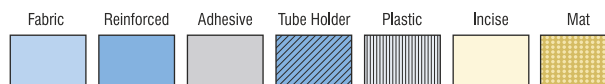

Cath Lab Pack : Product Code - #66021-0000

FEMORAL DRAPE

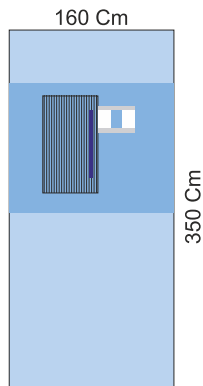

BACK VIEW

Item Code	Qty.	Contents	Size(cm)
318-080-100S	1 PC	Back Table Cover Reinforced	100x80
CR 143027-031	2 PCS	Surgical Gown Reinforced	M
CR 143029-000	2 PCS	Hand Towels	30x30
060-160-240S	1 PC	Laminated Absorbent Sheet	160x240
41104-0000	1 PC	Femoral Drape <ul style="list-style-type: none"> • 13x10 Cm Fenestration • Absorbent Laminated Reinforcement • Adhesive • Fluid Collection Pouch 	
CP 141066-000	1 PC	Carry Bag	

LAMINATED ABSORBENT SHEET

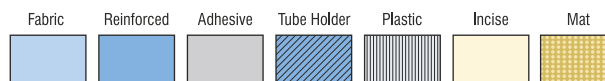
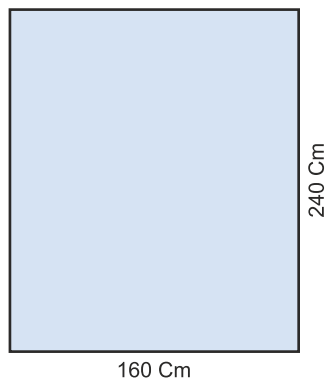

Coronary Artery By Pass Pack : Product Code - #66202-0000

CABG DRAPE

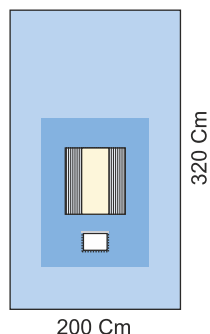

200 Cm

320 Cm

BILATERAL UNDER LEG DRAPE

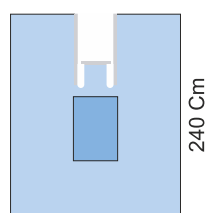

200 Cm

240 Cm

DAITHERMY BAG

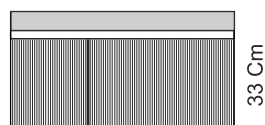

40 Cm

33 Cm

Item Code	Qty.	Contents	Size(cm)
085-160-225S	1 PC	Back Table Cover Reinforced	160x225
CR 143029-000	4 PC	Hand Towels	30x30
CR 143039-000	1 PC	Mayo Cover Reinforced	80x80
CR 142043-000	2 PC	ISO Seal Drape Tape Strips	10x45
043-160-100A	1 PC	Surgical Sheet with Adhesive	160x100
085-160-125S	1 PC	Trolley Sheet	160x125
42012-0000	1 PC	Bi-Lateral Underleg Drape	
		<ul style="list-style-type: none"> ● Adhesive ● Absorbent Laminated Reinforcement ● 10x25 Cm Split 	
CP 1443086-002	2 PC	Tube Holder with Velcro	5x25
		<ul style="list-style-type: none"> ● Adhesive ● Velcro 	
CR 142002-001	1 PC	Diathermy Bag	30x35
		<ul style="list-style-type: none"> ● Adhesive 	
CR 143041-012	6 PC	Mopping Pad	30x30
42001-0000	1 PC	Cardio vascular Drape with Pockets	
		<ul style="list-style-type: none"> ● Adhesive ● Incise ● Absorbent Laminated Reinforcement ● 45x20 Cm Fenestration ● Pockets 	
CP 141066-000	1 PC	Carry Bag	

